









UT8777RK Smart Repair Tool Kit

NO	ITEM	Q'ty	Photo
1	1/4" Mini Angle Die Grinder	1	
2	3mm Collet	1	
3	Sapnner Wrench	2	
4	2" Backing Pad 1/4"-20	1	
5	2" Coarse Surface Prep Pad	2	
6	2" Med Surface Pad	2	
7	2" Fine Surface Prep Pad	2	
8	2" #24 Grit Sanding Disc	2	
9	2" #36 Grit Sanding Disc	2	
10	2" #50 Grit Sanding Disc	2	

ANGLE HEAD DIE GRINDER

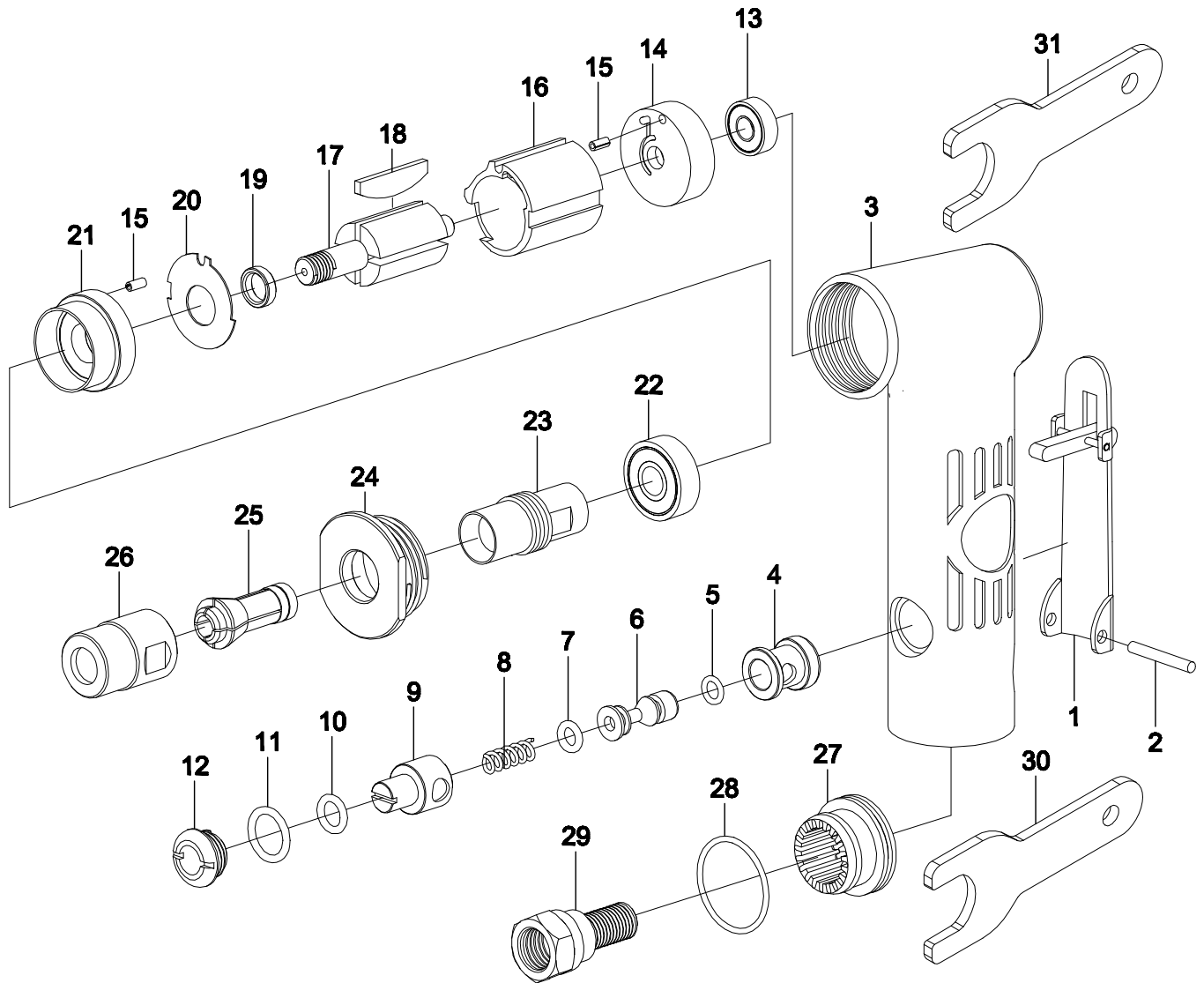

Ref.No.	Part No.	Description	Q'ty	Ref.No.	Part No.	Description	Q'ty
1	308A0001	Throttle Lever	1	17	308A0017	Rotor	1
2	308A0002	Spring Pin	1	18	308A0018	Blade	4
3	308A0003	Housing	1	19	308A0019	Collar	1
4	308A0004	Valve Bushing	1	20	308A0020	Steel Plate	1
5	308A0005	O-Ring	1	21	308A0021	Front Plate	1
6	308A0006	Valve Stem	1	22	308A0022	Bearing	1
7	308A0007	O-Ring	1	23	308A0023	Spindle	1
8	308A0008	Valve Spring	1	24	308A0024	Lock Ring	1
9	308A0009	Air Controller	1	25	308A0025	Collet	1
10	308A0010	O-Ring	1	26	308A0026	Collet Nut	1
11	308A0011	O-Ring	1	27	308A0027	Exhaust Sleeve	1
12	308A0012	Valve Screw	1	28	308A0028	O-Ring	1
13	308A0013	Bearing	1	29	308A0029	Air Inlet	1
14	308A0014	End Plate	1	30	308A0030	Wrench(11mm)	1
15	308A0015	Pin	2	31	308A0031	Wrench(17mm)	1
16	308A0016	Cylinder	1				